

Harbor Freight Central Machinery 7x12 Mini Lathe - Model 93799 (C2)

Drawing 1 of 2

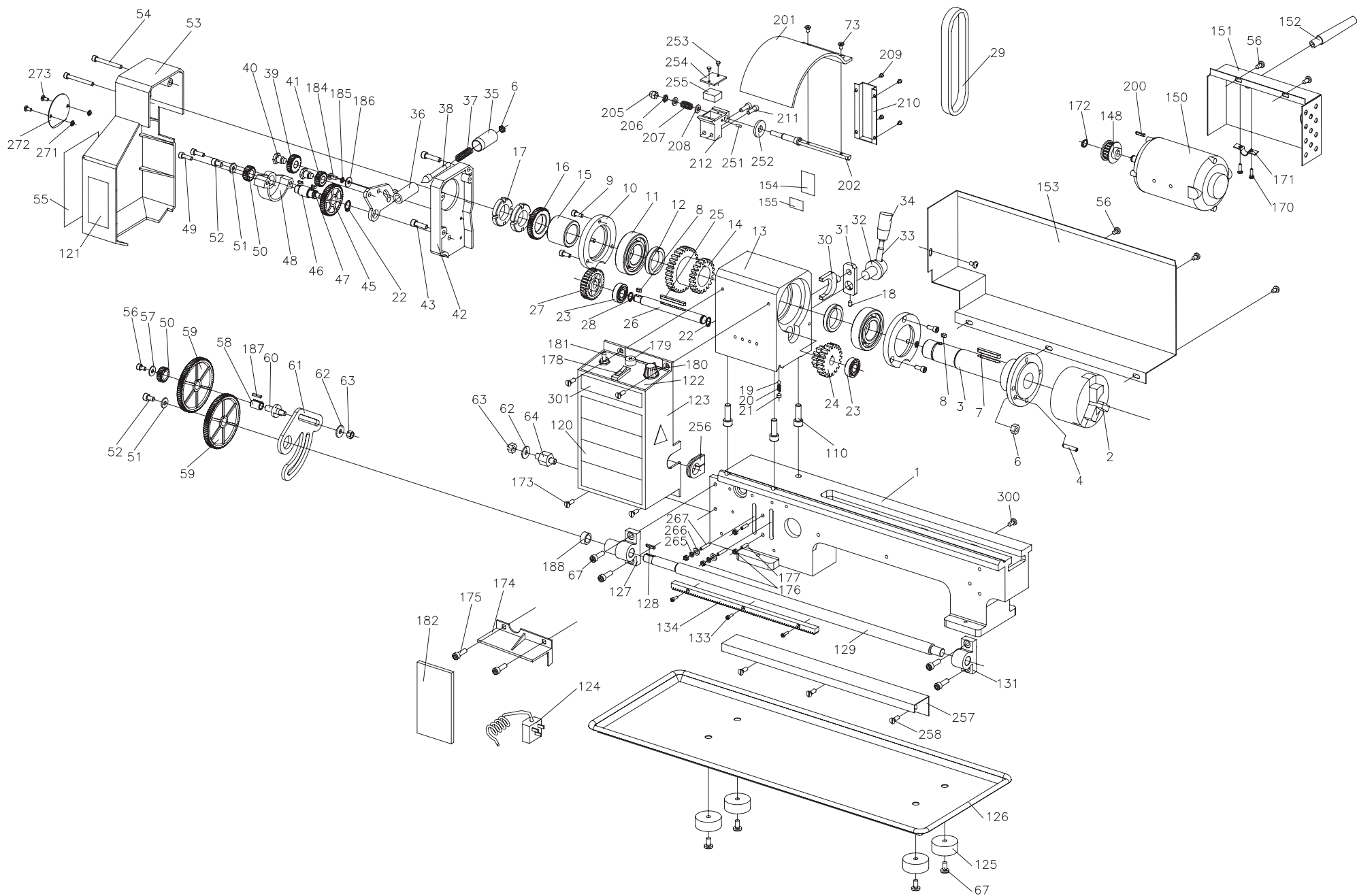

Harbor Freight Central Machinery 7x12 Mini Lathe - Model 93799 (C2)

Drawing 2 of 2

